



## NanoCom AX100

## Datasheet

Long-range software configurable VHF/UHF transceiver

Product name: NanoCom AX100

Document No.: 1013823

Revision: 3.7

Author: ROBB

Approved by: MOV

Approval date: 26-11-2019

## Confidentiality Notice

This document is submitted for a specific purpose as agreed in writing and contains information, which is confidential and proprietary. The recipient agrees by accepting this document, that this material will not be used, transferred, reproduced, modified, copied or disclosed in whole or in part, in any manner or to any third party, except own staff to meet the purpose for which it was submitted without prior written consent.

GomSpace © 2019

# 1 Table of Contents

<b>2</b>	<b>OVERVIEW .....</b>	<b>4</b>
2.1	Highlighted Features.....	4
2.2	Block Diagram .....	5
2.3	Functional Description .....	5
2.4	Available Ordering Options.....	6
<b>3</b>	<b>HARDWARE LAYOUT, CONNECTORS AND PIN OUT .....</b>	<b>7</b>
3.1	AX100 Top .....	7
3.1.1	J2 - Picoblade Connector .....	7
3.1.2	J3 - Picoblade USART (debug) Connector.....	7
3.1.3	J4 - MCX RF Connector .....	7
3.2	AX100 Bottom.....	9
3.2.1	J1 - FSI Main Connector.....	9
<b>4</b>	<b>DATA INTERFACE .....</b>	<b>10</b>
4.1	I <sup>2</sup> C/TWI .....	10
4.2	KISS.....	10
4.3	CAN-BUS / CFP .....	10
<b>5</b>	<b>DEBUG INTERFACE.....</b>	<b>11</b>
<b>6</b>	<b>ABSOLUTE MAXIMUM RATINGS.....</b>	<b>11</b>
<b>7</b>	<b>ELECTRICAL CHARACTERISTICS .....</b>	<b>11</b>
<b>8</b>	<b>RF CHARACTERISTICS .....</b>	<b>12</b>
8.1	Transmitter.....	12
8.1.1	Narrow band TX spectrum.....	12
8.1.2	Output power vs. frequency.....	13
8.2	Receiver.....	14
8.2.1	Sensitivity.....	14
8.2.2	AFC performance .....	14
8.2.3	Wideband blocking performance (AX100U) .....	15
8.2.4	Narrow Band Blocking (AX100UL) .....	16
<b>9</b>	<b>LINK BUDGET .....</b>	<b>18</b>
9.1	Downlink .....	18
9.2	Uplink.....	19
<b>10</b>	<b>ENVIRONMENT TESTING .....</b>	<b>20</b>
10.1	RF qualification .....	20
<b>11</b>	<b>APPLICATION NOTES.....</b>	<b>20</b>
11.1	Antenna/Receiver Diversity Setup.....	20
11.2	GomSpace Ground Unit .....	20
11.3	Redundant radios .....	21
<b>12</b>	<b>MOUNTING.....</b>	<b>22</b>
<b>13</b>	<b>DISCLAIMER .....</b>	<b>22</b>
<b>14</b>	<b>MECHANICAL DRAWING.....</b>	<b>23</b>

## 2 Overview

The NanoCom AX100 (AX100) is a half-duplex software configurable radio transceiver specifically designed for long-range transmissions. The combination of forward error correction, AFC and digital filters results in a high sensitivity system, without sacrificing flexibility. The radio module supports full on-orbit reconfiguration of the frequency, bitrate, filter-bandwidth, and modulation type. Smart CSMA/CA (listen before talk) medium access control combined with a small RX/TX switching duration gives a short satellite ping time, thus effectively removing the need for full-duplex radios, even for high volume data download. In turn this simplifies satellite design, because only a single antenna is required.

The integrated design of microcontroller, transmitter, receiver, LNA and power amplifier results in a small PCB module that fits up to four times onto a CubeSat PCB. Multiple hardware components are reused from the NanoCom U482C, including the PA, DC-DC converter, RX/TX switch, microcontroller, oscillators, and RAM memory.

### 2.1 Highlighted Features

- Advanced high performance narrow-band transceiver for UHF and VHF
- GFSK/GMSK
- Data rates from 0.1 kbps to 38.4 kbps
- Class leading sensitivity down to  $-137$  dBm at 100 bps with FEC
- RF carrier frequency and FSK deviation programmable in 1 Hz steps
- Automatic frequency control (AFC)
- Transmitter with adjustable 24 to 30 dBm output power at  $> 45$  % PAE
- RF parameters are fully configurable on-orbit. E.g. carrier frequency, filter bandwidths, baud rate, framing etc. can be altered on the go.
- Frame encapsulation:
  - 32-bit ASM + Golay encoded variable length field.
  - HDLC and AX25 available for legacy systems
  - HDLC with  $r \frac{1}{2} k=7$  viterbi encoding
  - AX.25
- Framing options:
  - Reed Solomon FEC (223,255)
  - CRC32
  - CCSDS Randomization
  - HMAC (authentication)
- Multiple CSP data interfaces: I<sup>2</sup>C, UART, CAN-Bus
- 32 kB FRAM for persistent configuration storage
- RTC clock
- Adjustable over-temperature protection
- High-efficiency buck-converter for transmitter supply
- Compact daughter-board form-factor (compatible with GomSpace NanoDock's)
- Operational temperature:  $-30$  °C to  $+85$  °C
- Dimensions: 65 mm x 40 mm x 6.5 mm
- Mass: 24.5 gram
- 20-position hard-gold plated FSI one-piece connector
- UART/GOSH console interface for easy use in lab setup
- MCX antenna connector
- Integrated heat sink (also works as EMI shield).
- PCB material: Glass/Polyimide 4+4 twin stack ESA ECSS-Q-ST-70-11-C
- IPC-A-610 Class 3 assembly

## 2.2 Block Diagram

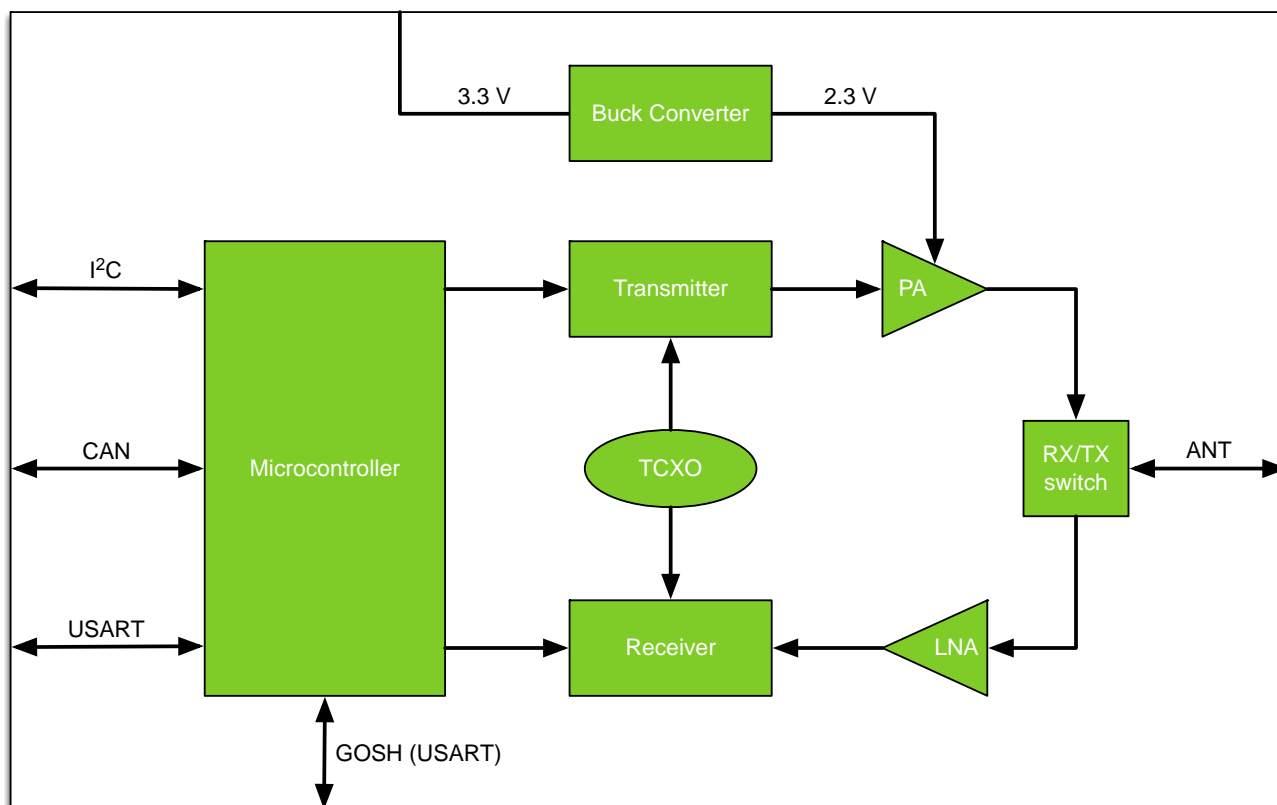

The Microcontroller has three satellite bus connections; it can use I<sup>2</sup>C, CAN-BUS or USART. Furthermore it has a separate USART for the GOSH debugging console. Finally the RF connector is a single SMA 50 Ω for both RX and TX.

## 2.3 Functional Description

The design is built around proven components; the PA, LNA, TCXO and RX/TX switch are proven components from previous GomSpace products. The microprocessor is a new variant of a formerly proven processor, which now features the CAN-BUS interface too.

The RF frequency generation subsystem consists of a fully integrated synthesizer, which multiplies the reference frequency from the crystal oscillator to get the desired RF frequency. The advanced architecture of the synthesizer enables frequency resolutions of 1 Hz, as well as fast settling times of 5 – 50 μs. Fast settling times mean fast start-up and fast RX/TX switching, enabling low-power system design.

The Power Amplifier is a two stage 25 dB gain with a maximum output of 33 dBm (derated to 30 dBm). A temperature sensor has been placed very close to the PA to prevent the system from overheating. A software programmable max temperature can be set, at which point the microcontroller will immediately shut down the transmitter. The heat from the power amplifier is spread through several layers of ground plane and through an aluminum heat sink, which also doubles as an EMI shield.

The LNA is a medium gain monolithic amplifier with a low noise figure (~1dB) selected for its simplicity and stability.

The RX/TX switch is rated for 5 W and is robust enough to handle a severe antenna mismatch, for example if the antenna cable is not inserted while powering on the amplifier. This is of course hypothetical and should not be done with flight hardware.

The TCXO has a frequency stability of +/- 2.5 ppm over the entire temperature range, and removes the need to do frequency-offset calibration after satellite deployment. The built-in AFC will correct for any minor frequency variations up to +/- one quarter of the receiver bandwidth.

## 2.4 Available Ordering Options

The AX100 comes in several variants a U for UHF, UL for UHF-Low and V for VHF. The difference is in the RF match and output filters used.

Variant	Description
<b>AX100U</b>	UHF 430-440 MHz (except 431.9 – 432.1 and 439.9 – 440.1 MHz) <sup>1</sup>
<b>AX100UL</b>	UHF-Low 395-405 MHz (except 399.9 – 400.1 MHz) <sup>1</sup>
<b>AX100V</b>	VHF 143-150 MHz (except 143.9 – 144.1 MHz) <sup>1</sup>

Other variants can be produced on request.

<sup>1</sup> The hole in the range is caused by intermodulation with the reference XO and will cause spurs if selected closer than 100 KHz to a multiple of 16 MHz for AX100V and 8 MHz for AX100U / UL operating at up to 38400 bps.

## 3 Hardware Layout, Connectors and Pin Out

### 3.1 AX100 Top

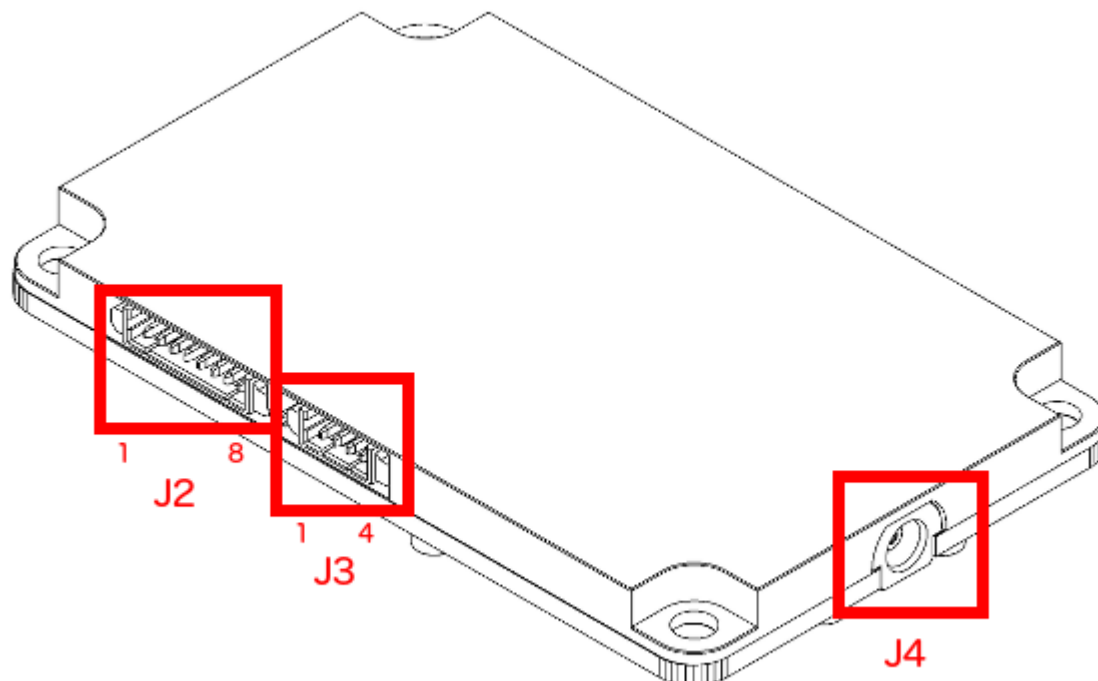

Figure 1 AX100 top connectors

#### 3.1.1 J2 - Picoblade Connector

The JTAG interface is used for factory software upload only. The AX100 module will ship with firmware pre-installed. Uploading new firmware will void the factory checkout.

#### 3.1.2 J3 - Picoblade USART (debug) Connector

The debug USART is designed for easy-access to the NanoCom AX100 configuration and makes it possible to do factory checkout of standalone modules. Note: you will have to use this interface to save the default configuration into the FRAM write protected area.

**Warning:** please only supply the AX100 from a single power-supply. So, if you have the debug USART connected to a PC and power is coming from the NanoDock, you must disconnect pin 2 in the debug connector. Also take special care about grounding when connecting a laptop with an external switch-mode power supply. These tend to produce a high common-mode noise, which can damage the PCB's if not grounded correctly. Serial port settings are 500000 baud and 8n1.

Pin	Description
1	GND
2	VCC 3.3 V
3	USART2 RX (Data to AX100)
4	USART2 TX (Data from AX100)

#### 3.1.3 J4 - MCX RF Connector

The RF connector is a 50  $\Omega$  MCX for edge mounting.

It works well with a right angle connector on a RG316 or RG178 cable. Note: The cables should be made without the typical black heat-shrink tubing to avoid outgassing in vacuum.



**Warning:** Please do not transmit without a proper 50  $\Omega$  termination. This will reflect the TX power back into the transmitter and may cause permanent damage to the RX/TX switch and the power amplifier.



### 3.2 AX100 Bottom

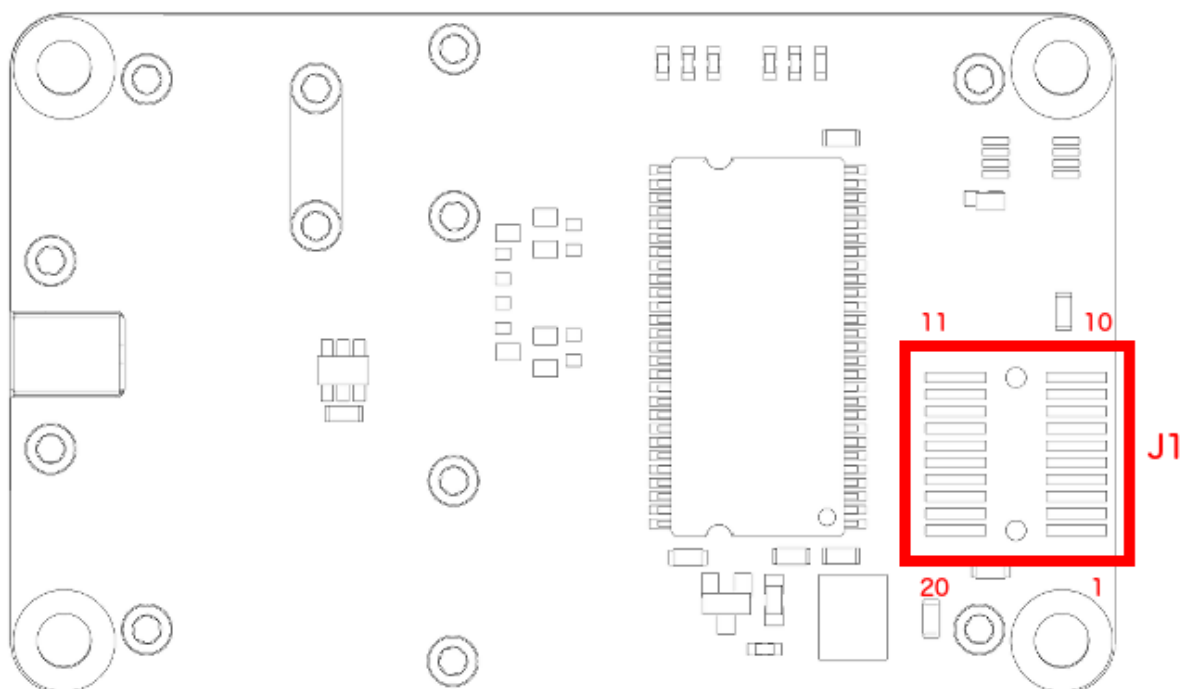

#### 3.2.1 J1 - FSI Main Connector

The main connector is built into the PCB as a 20-position hard-gold plated FSI one-piece connector. The connector is a: SAMTEC-FSI-110-D. The module is connected to the NanoDock PCB by fastening it with 4 screws. The alignment is done with two plastic pins that fit in two holes on the AX100 module. The overall stacking height between the NanoDock and the AX100 module's underside is 3.0 mm. A 3.0 mm spacer must therefore be used in each of the four corners.

Pin	Description	Pin	Description
1	GND	20	GND
2	GND	19	GND
3	VCC 3.3 V	18	VCC 3.3 V
4	VCC 3.3 V	17	VCC 3.3 V
5	I <sup>2</sup> C SCL	16	Not connected
6	I <sup>2</sup> C SDA	15	Not connected
7	CAN HIGH	14	Not connected
8	CAN LOW	13	Not connected
9	USART4 RX (data to AX100)	12	Not connected
10	USART4 TX (data from AX100)	11	Not connected

## 4 Data Interface

The NanoCom AX100 uses the CubeSat Space Protocol (CSP) to transfer data to and from CSP nodes on-board the main system bus. CSP is a routed network protocol that can be used to transmit data packets between individual subsystems on the satellite bus and between the satellite and ground station. For more information about CSP please read the documentation on [libcsp.org](http://libcsp.org) and on Wikipedia: [http://en.wikipedia.org/wiki/Cubesat\\_Space\\_Protocol](http://en.wikipedia.org/wiki/Cubesat_Space_Protocol)

The CSP network layer protocol spans multiple data-link layer protocols, such as KISS, I<sup>2</sup>C and Can Fragmentation Protocol (CFP).



### 4.1 I<sup>2</sup>C/TWI

The standard method to communicate with the AX100 radio is over multi-master I<sup>2</sup>C/TWI. Please note that since the CSP router sends out an I<sup>2</sup>C message automatically when data is ready for a subsystem residing on the I<sup>2</sup>C bus. The bus needs to be operated in I<sup>2</sup>C multi-master mode. Currently there is no support for I<sup>2</sup>C slave mode, please contact GomSpace for more information about this.

The AX100 uses the same I<sup>2</sup>C address as the CSP network address per default. This means that if a message is sent from the radio link, to a network node called 1, the AX100 will route this message to the I<sup>2</sup>C interface with the I<sup>2</sup>C destination address 1.

The AX100's own I<sup>2</sup>C address is 0x05 per default.

### 4.2 KISS

The KISS protocol uses special framing characters to identify a data-packet on a serial connection. It is designed to be easy to implement in simple embedded devices, which are capable of asynchronous serial communications. [http://en.wikipedia.org/wiki/KISS\\_\(TNC\)](http://en.wikipedia.org/wiki/KISS_(TNC))

It is possible to communicate with the AX100 over a serial connection using USART2 and USART4 in the main FSI connector or on the debug output. *Note: Please be aware that the debug USART is also used for debugging messages so it is not recommended for the main data interface for the AX100. Because debug messages and KISS data frames can collide and thereby corrupt a message.*

Please contact GomSpace for more information about how to use the USART as the default interface.

### 4.3 CAN-BUS / CFP

The CAN interface to the AX100 can be used together with CAN Fragmentation Protocol (CFP), a data-link layer protocol specially developed for CSP. CFP is a simple method to make CSP packets of up to 256 bytes, span multiple CAN messages of up to 8 bytes each. The easiest way to implement CSP/CFP over CAN is to download the CSP source code from <http://libcsp.org> and compile the CFP code directly into your own embedded system.

Please contact GomSpace for more information about how to use the CAN-BUS as the default interface.

## 5 Debug Interface

The debug interface is a USART that uses the GomSpace Shell (GOSH) to present a console-like interface to the user. GOSH is a general feature present on all GomSpace products. To read more about GOSH please check [www.gomspace.com](http://www.gomspace.com)

The console can be used during checkout of the AX100 to send commands and set parameter. During integration into the satellite, the debug interface can be used to evaluate and see incoming and outgoing traffic through the AX100 radio. Telemetry and housekeeping parameters can also be monitored. Here is a short list of features of the debug interface:

- Inspect CSP traffic (incoming and outgoing)
- Inspect I<sup>2</sup>C driver (useful during early driver development)
- Inspect runtime performance
- Run tests (ping, BER, etc.)
- Modify routing table
- Modify, save and restore default parameters
- Set Frequency, Bitrate, Bandwidth, etc.

## 6 Absolute Maximum Ratings

Stresses above those listed under Absolute Maximum Ratings may cause permanent damage to the AX100. Exposure to absolute maximum rating conditions for extended periods may affect the reliability.

Symbol	Description	Min.	Max.	Unit
VCC	Supply voltage	3.3	3.4	V
I	Supply current draw	-	1.2	A
P <sub>in</sub>	Absolute maximum input power at receiver input		-5	dBm
T <sub>amb</sub>	Operating Temperature	-30	85	°C
T <sub>stg</sub>	Storage Temperature	-30	85	°C
V <sub>io</sub>	Voltage on I <sup>2</sup> C/USART/JTAG pins	-0.3	3.6	V
VSWR	Output Load VSWR		10:1	

## 7 Electrical Characteristics

Symbol	Description	Min.	Typ.	Max.	Unit
VCC	Supply voltage		3.3		V
I <sub>rx</sub>	Supply current RX	45	55	120	mA
I <sub>tx nominal temp</sub>	Supply current TX, max PCL, temperature +25C	750	800	850	mA
I <sub>tx extreme temp</sub>	Supply current TX, max PCL, temperature -30C to +85C	600		1000	mA

## 8 RF Characteristics

### 8.1 Transmitter

Symbol	Description	Min.	Typ.	Max.	Unit
<b>SBR<sub>TX</sub></b>	Signal bit rate (within 25 kHz BW)	500	4800	19200	bps
<b>SBR<sub>TX2</sub></b>	Signal bit rate (capable)	500	4800	38400	bps
<b>P<sub>out</sub></b>	Output power at RF connector	29	30	31	dBm
<b>F<sub>PS</sub></b>	Switch mode power supply frequency		1		MHz
<b>THD</b>	Total harmonic distortion	0.40	0.50	1.50	%
<b>H<sub>2</sub></b>	2.nd harmonic		-45	-40	dBc
<b>H<sub>3</sub></b>	3.rd harmonic		-50	-48	dBc
<b>F<sub>stability</sub></b>	Frequency stability		2.5		PPM
<b>P<sub>no</sub></b>	Phase noise 1 MHz offset, GFSK 4800bps		-100		dBc/Hz
<b>F<sub>step</sub></b>	Programmable Frequency Step		0.98		Hz
<b>T<sub>start</sub></b>	Synthesizer start up time	5	25	25	µs
<b>BW</b>	Loop bandwidth	50	500	500	kHz
<b>P<sub>adj</sub></b>	Adjacent channel power, GFSK 4800bps, 25kHz channel spacing		-50	-45	dBc

#### 8.1.1 Narrow band TX spectrum

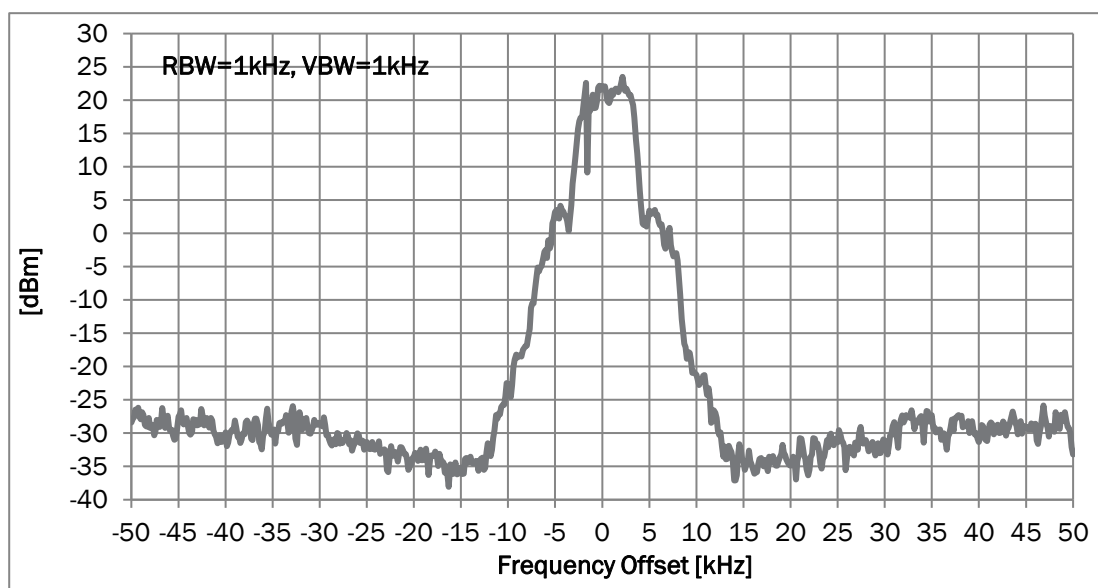

Figure 2 AX100U + UL Narrow Band TX spectrum 4800 baud, GFSK, m=0.667

### 8.1.2 Output power vs. frequency

The output has a wide match from 430 to 450 MHz for the U-version and from 390 to 415 for the UL-version.

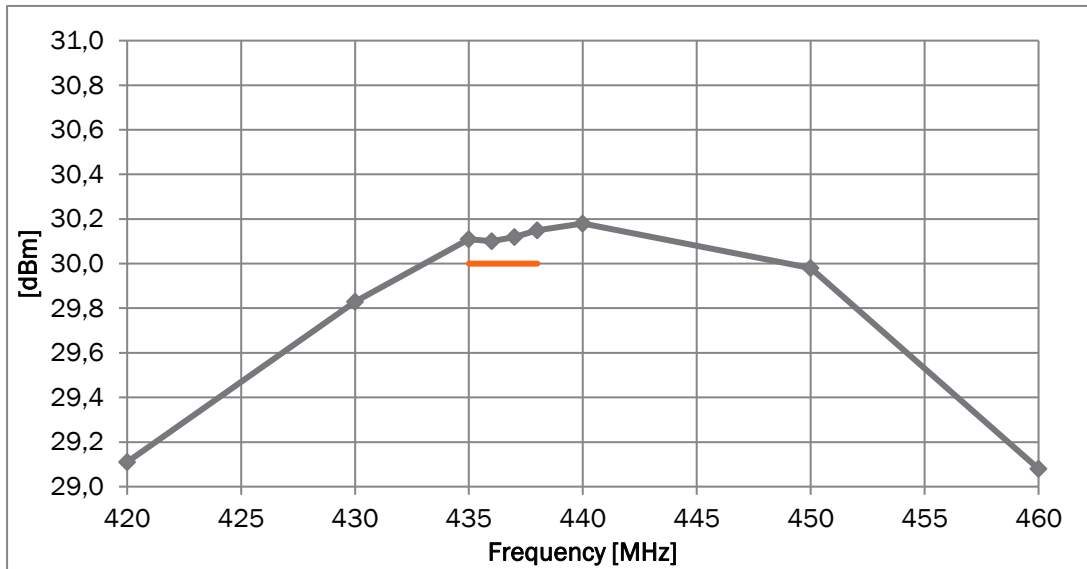

Figure 3 AX100U Output power versus frequency

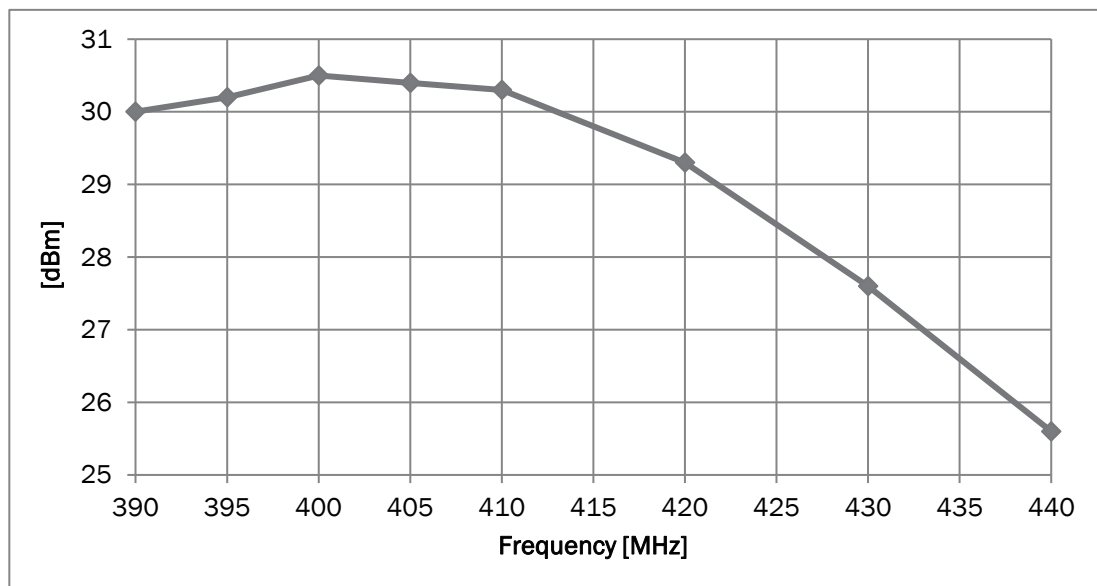

Figure 4 AX100UL Output power versus frequency

## 8.2 Receiver

Symbol	Description	Min.	Typ.	Max.	Unit
<b>SBR<sub>RX</sub></b>	Signal bit rate	100	4800	38400	bps
<b>IS<sub>600,FEC</sub></b>	Sensitivity 600 baud w/ FEC		-132		dBm
<b>IS<sub>5000,FEC</sub></b>	Sensitivity 5000 baud w/ FEC		-122		dBm
<b>IS<sub>50000,FEC</sub></b>	Sensitivity 50.000 baud w/ FEC		-111		dBm
<b>SEL</b>	Adjacent channel suppression <sup>3</sup>		30	40	dB
<b>BLK</b>	Blocking at +/- 10 MHz <sup>4</sup>		78		dB
<b>R<sub>AFC</sub></b>	AFC pull-in range		25		% BW
<b>R<sub>DROFF</sub></b>	Data rate pull-in range		10		%

### 8.2.1 Sensitivity

The following graph shows the sensitivity as a function of received signal strength at different bitrates. The packet error rate depends on the amount of FEC enabled. The Reed-Solomon coding is capable of correcting 16 bytes per block of up to 223 bytes. The combination of Viterbi (HDLC/FEC mode) and Reed-Solomon gives a very good FEC performance. More results on the PER will follow in future versions of this document.

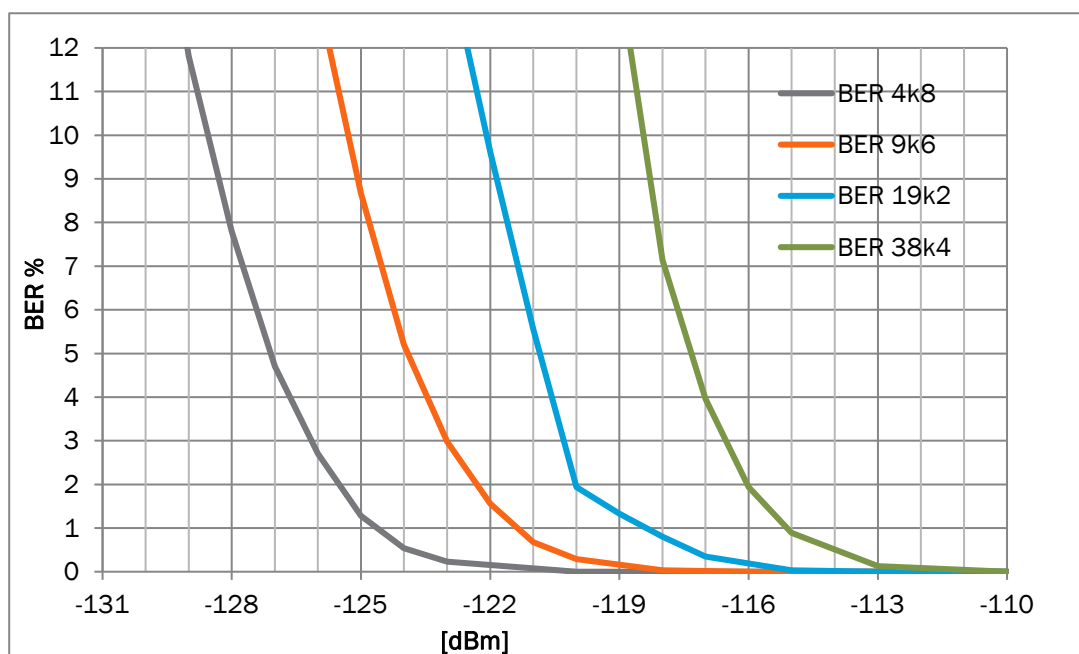

Figure 5 Receiver sensitivity

### 8.2.2 AFC performance

The following graphs shows that there is no AFC performance penalty until the boundary for the AFC tracking is met at +/- 25% of the Receiver bandwidth.

<sup>3</sup> Interferer/Channel @ BER = 10<sup>-3</sup>, channel level is +3 dB above the typical sensitivity, the interfering signal is CW; channel signal is modulated with shaping

<sup>4</sup> Channel/Blocker @ BER = 10<sup>-3</sup>, channel level is +3 dB above the typical sensitivity, the blocker signal is CW; channel signal is modulated with shaping

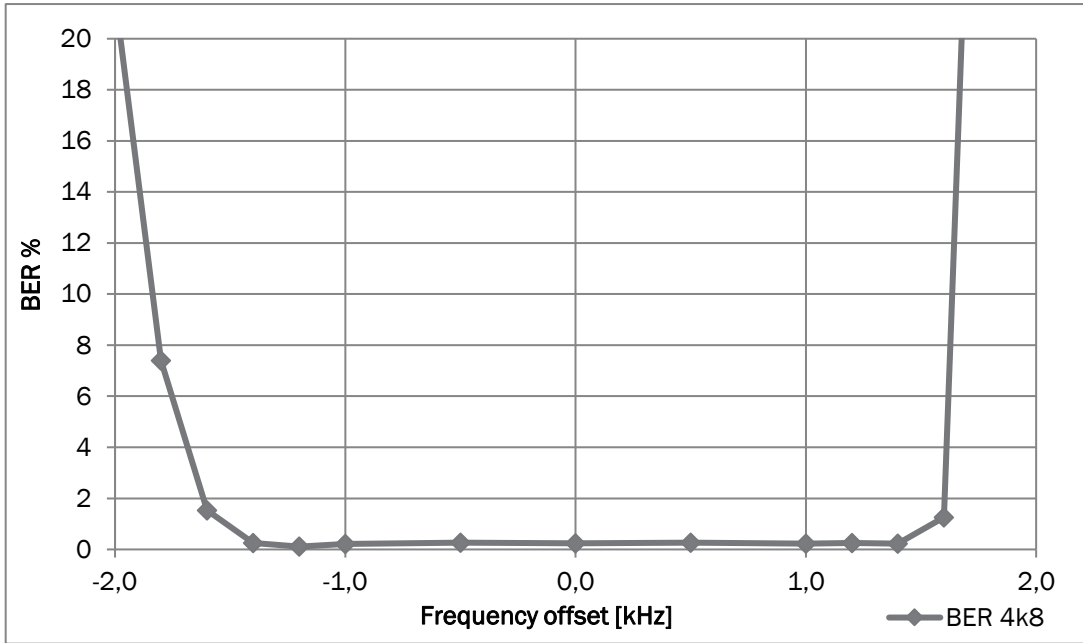

Figure 6 AFC performance

### 8.2.3 Wideband blocking performance (AX100U)

The following tests were performed with the signal of: GFSK, 436.5MHz, 4k8, -123dBm and a constant carrier blocker of: -80 dBm.

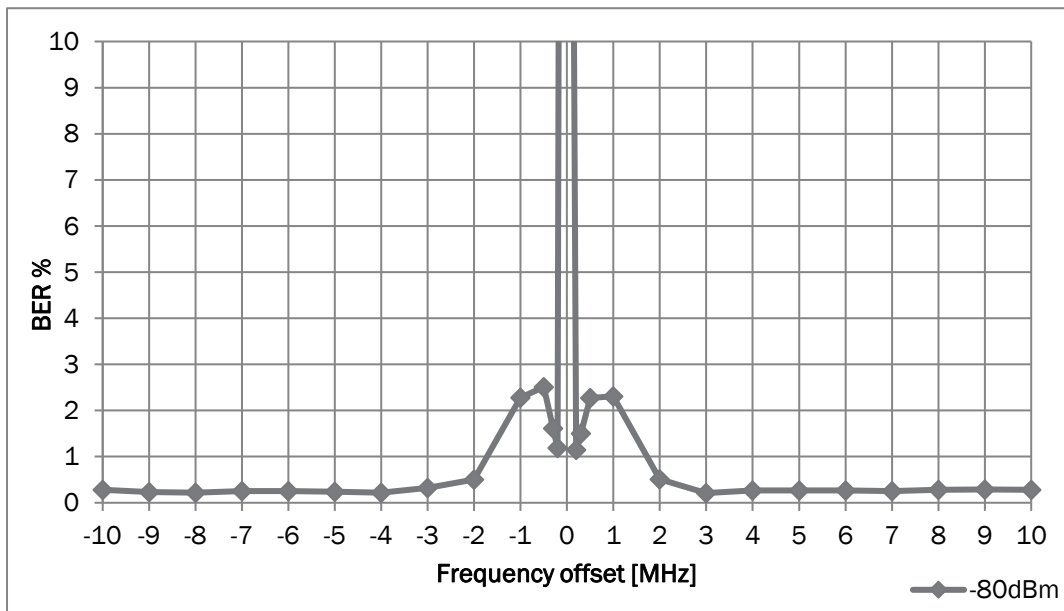

Figure 7 Blocking performance

The following graph shows the blocking due to the absolute power level at frequencies far from the receiver.

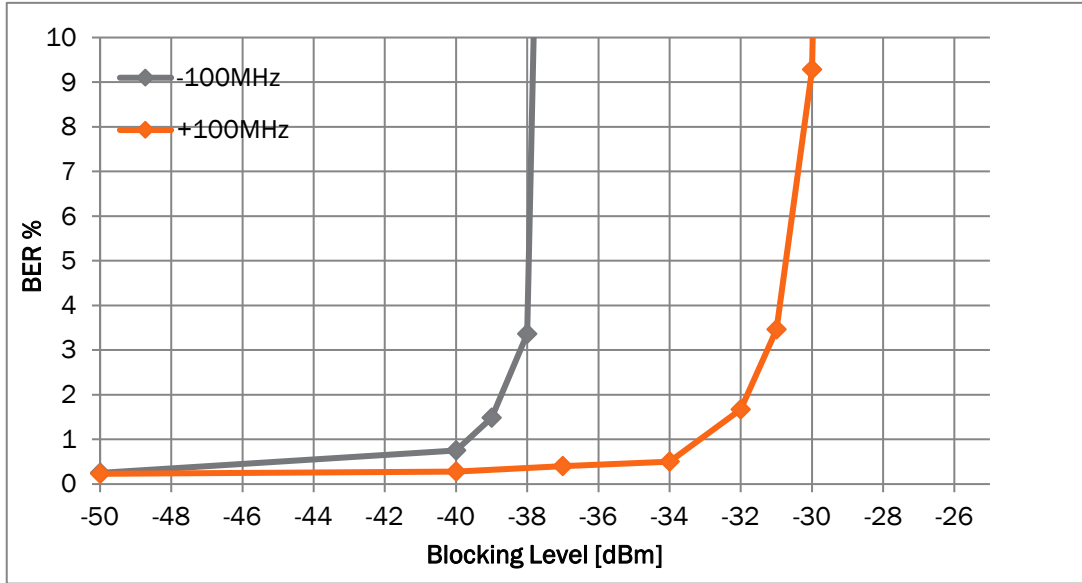

Figure 8 Far blocking performance

The following graph shows specific blocking results at known frequency bands where signals are usually found near a ground-station.

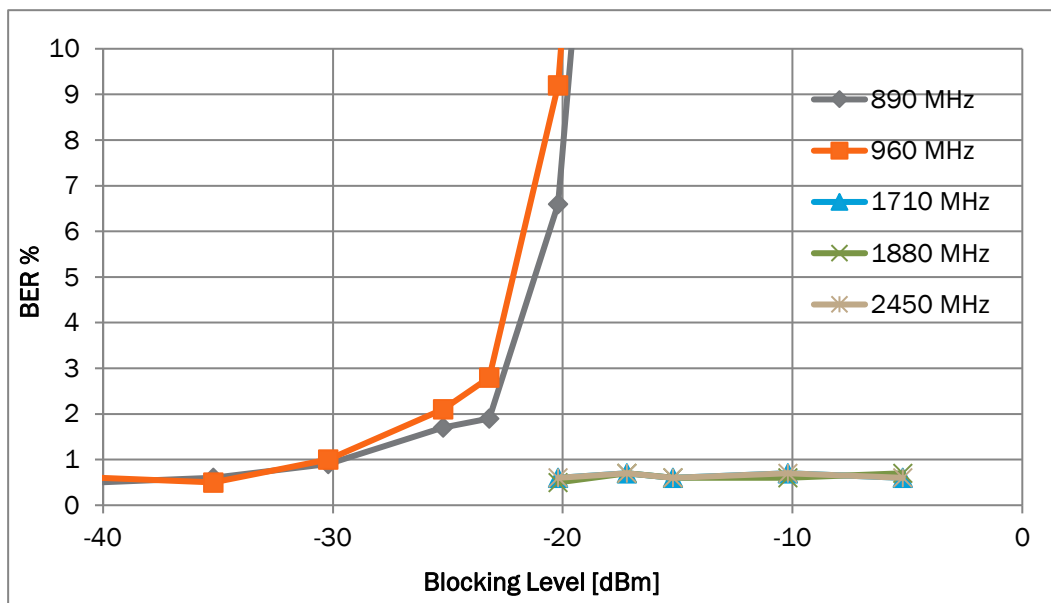

Figure 9 Ground Frequency blocking performance

### 8.2.4 Narrow Band Blocking (AX100UL)

These narrow band blocking tests were performed on the AX100 UL. The wanted signal is 401MHz 4800 baud GFSK at a level of -123 dBm. This is raised 3 dB above the typical sensitivity. The blocking signal are swept in frequency and the test have been performed both at +40 dB and +30 dB relative to the wanted signal.



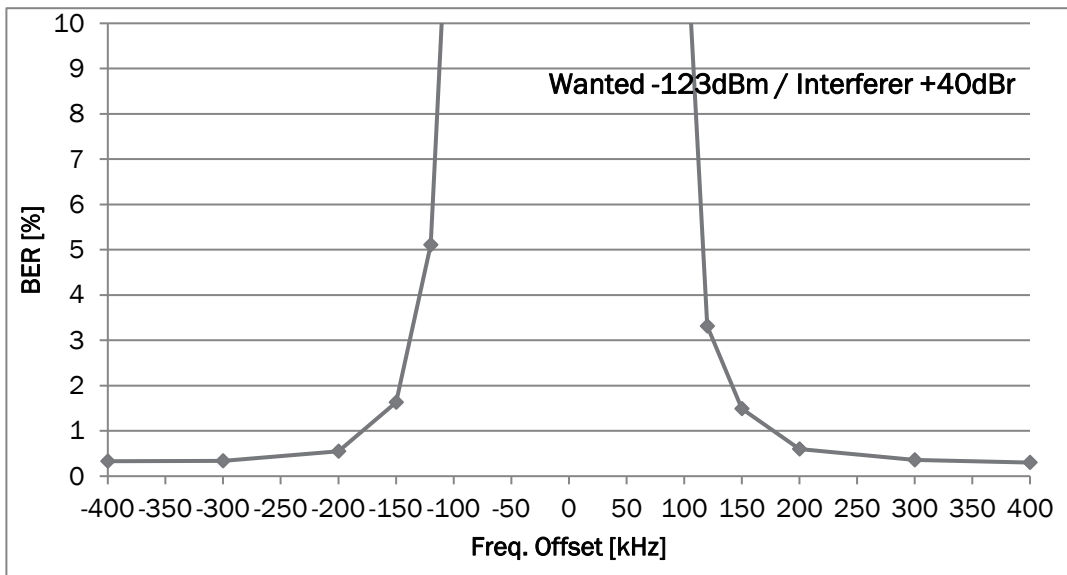

Figure 10 Narrowband blocking at 401 MHz, wanted -123 dBm, interferer +40 dB

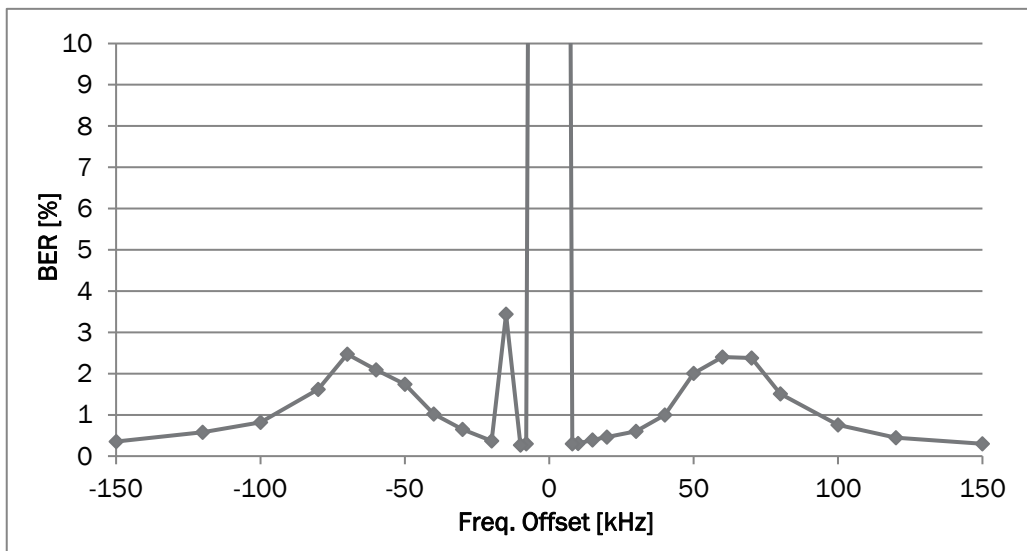

Figure 11 Narrowband blocking at 401 MHz, wanted -123 dBm, interferer +30 dB

It is interesting to notice that there is a lower sensitivity when the interfering signal is at -15 kHz. This is caused by internal mixing with the local oscillator, which sits below the center frequency.

## 9 Link Budget

Name	Description	Value
Frequency	UHF	437.5 MHz
Symbol rate	Symbols / second	9600
Ant SAT	Canted Turnstile GomSpace ANT430	Omnidirectional
Ant GND	Dual crossed Yagi's	17 dBi gain
Orbit	Low earth polar orbit	700 km circular
Elevation	Angle from horizon to satellite	5 degrees

### 9.1 Downlink

Parameter:	Value:	Units:
<b>Spacecraft:</b>		
Spacecraft Transmitter Power Output:	1,0	watts
In dBW:	0	dBW
In dBm:	30,0	dBm
Spacecraft Total Transmission Line Losses:	0,5	dB
Spacecraft Antenna Gain:	0	dBi
Spacecraft EIRP:	<b>-0,5</b>	dBW
<b>Downlink Path:</b>		
Spacecraft Antenna Pointing Loss:	0	dB
S/C-to-Ground Antenna Polarization Loss:	3	dB
Path Loss:	153	dB
Atmospheric Loss:	2,1	dB
Ionospheric Loss:	0,4	dB
Rain Loss:	0,0	dB
Isotropic Signal Level at Ground Station:	<b>-159,0</b>	dBW
<b>Ground Station (EbNo Method):</b>		
Ground Station Antenna Pointing Loss:	0,5	dB
Ground Station Antenna Gain:	17	dBi
Ground Station Total Transmission Line Losses:	0,5	dB
Ground Station Effective Noise Temperature:	1003 <sup>5</sup>	K
Ground Station Figure of Merit (G/T):	-13,5	dB/K
G.S. Signal-to-Noise Power Density (S/No):	56,1	dBHz
System Desired Data Rate:	9600	bps
In dBHz:	39,8	dBHz
Telemetry System Eb/No for the Downlink:	16,3	dB
Demodulation Method Selected:	GMSK	
Forward Error Correction Coding Used:	Conv. R=1/2,K=7 & R.S. (255,223)	
System Allowed or Specified Bit-Error-Rate:	1,0E-05	
Eb/No Threshold:	7,8	dB
System Link Margin:	8,5	dB

<sup>5</sup> For a very noisy city environment

## 9.2 Uplink

Parameter:	Value:	Units:
<b>Ground Station:</b>		
Ground Station Transmitter Power Output:	25,0	watts
In dBW:	14,0	dBW
In dBm:	44,0	dBm
Ground Stn. Total Transmission Line Losses:	1,6	dB
Antenna Gain:	17	dBi
Ground Station EIRP:	29,4	dBW
<b>Uplink Path:</b>		
Ground Station Antenna Pointing Loss:	0,5	dB
Gnd-to-S/C Antenna Polarization Losses:	3,0	dB
Path Loss:	153	dB
Atmospheric Losses:	2,1	dB
Ionospheric Losses:	0,4	dB
Rain Losses:	0,0	dB
Isotropic Signal Level at Spacecraft:	-129,6	dBW
<b>Spacecraft (Eb/No Method):</b>		
Spacecraft Antenna Pointing Loss:	0	dB
Spacecraft Antenna Gain:	0	dBi
Spacecraft Total Transmission Line Losses:	0,2	dB
Spacecraft Effective Noise Temperature:	234	K
Spacecraft Figure of Merit (G/T):	-23,9	dB/K
S/C Signal-to-Noise Power Density (S/No):	75,1	dBHz
System Desired Data Rate:	9600	bps
In dBHz:	39,8	dBHz
Command System Eb/No:	35,3	dB
Demodulation Method Selected:	GMSK	
Forward Error Correction Coding Used:	Conv. R=1/2,K=7 & R.S. (255,223)	
System Allowed or Specified Bit-Error-Rate:	1,0E-05	
Eb/No Threshold:	7,8	dB
System Link Margin:	<b>27,5</b>	dB

## 10 Environment Testing

To simulate the harsh conditions of launch and space, the AX100 has been exposed to a number of environment tests. For detailed information about the tests please contact GomSpace.

The AX100 has flown on several satellites and performed perfectly.

### 10.1 RF qualification

The AX100 have been RF Qualified with a third party RF consultant company: Satlinq Technology ApS. Here the transmit spectrum, harmonic distortion and phase noise have been verified to be within allowed ranges, and the receiver performance evaluated.

## 11 Application Notes

A key concept of the AX100 radio module is that it can be used as the both the space and ground transceiver in a mission. Having the same transceiver in both ends of a link greatly simplifies both the hardware and software development.

### 11.1 Antenna/Receiver Diversity Setup

The polarization of the radio-link will vary depending on the satellite antennas and the satellite orientation. An example antenna, the ANT430 is a circular polarized antenna with close to omnidirectional pattern. This antenna type is ideal for satellites that may be tumbling around its own axis because it can be received on a linear element with a maximum alignment loss of 3 dB if both vertical and horizontal antennas are used. The optimal solution would be to continuously monitor and switch between polarizations of the ground station antenna, but this is sometimes not feasible to have a ground station operator present to do that.

### 11.2 GomSpace Ground Unit

GomSpace has a complete ground unit system with antenna (AS100), radio unit (GS100) and a computer (MS100) with software to access and run a complete satellite mission.

The NanoCom GS100 radio unit ensures that no matter which polarization is optimal, one of the radios will be listening. Also it improves the G/T of the ground station, because the insertion loss of the polarization switch is avoided.

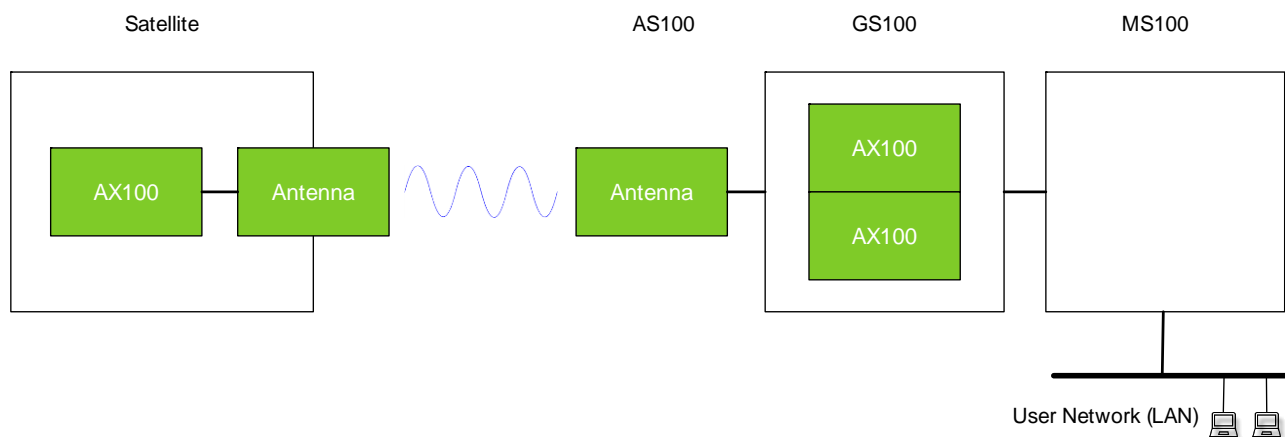

The GS100 is a 19" rack mounted unit that contains two AX100 compatible radio units and hence delivers the optimal solution described in the previous chapter.

Furthermore it contains:

- Output for a spectrum analyzer, useful in early deployment stage
- Centralized mission control and Doppler tracking
- Internal power supply

- Quad FTDI USB to USART interface. For full end-to-end testing in the lab

The MS100 is a 19" rack mounted computer filled with software to operate a satellite.

Software Includes

- CSP ground network consisting of
  - ZMQproxy, distributes messages between CSP nodes using ZMQ
  - ZMQbridge, translates from CSP/KISS to CSP/ZMQ
  - CSP-term, main operation software for GomSpace satellites
- Tracker software to control antenna movement, and Doppler compensation for the radio

The GomSpace AS100 antenna system completes the ground station. The AS100 is an almost 3 m high antenna tower with two Yagi antennas, an elevation rotor, an azimuth rotor.

Other features include:

- Sufficient antenna gain to close a typical low earth orbit satellite link budget
- Power handling capabilities allows direct connection to the radio
- Reliable and precise rotor control
- Sturdy design allows operations for many years

See the individual datasheets for further information.

### 11.3 Redundant radios

Having two radios on the satellite removes a single point of failure and adds the possibility of either cold or hot redundancy.

Two cold redundant AX100 radios would be controlled by the OBC or another system by simply switching the power to the AX100's off and on. In cold redundant mode, only one out of the two radios can be switched on at a time, and they share exactly the same network address and settings.

Hot redundancy would be where either or both radios can be turned on at a time. In this scenario routing is controlled by the network routing tables, and any system on the satellite could choose which radio it wants to use for downlink of data by setting the data-link address of its ground station or default routing entry. For uplink, both radios would receive the transmitted packet simultaneously and route that packet to the destination node simultaneously. This requires a simple packet de-duplication in the receiving node in order to a request being processed multiple times. Note: CSP currently does not have data de-duplication. Please contact GomSpace for more info about hot redundancy.

Another possibility would be to combine two AX100s as VHF/UHF. This would enable operation of both radios simultaneously for either two half-duplex links or a single full-duplex link. Note: GomSpace have not yet tested full duplex in operation.

## 12 Mounting

The AX100 module should be placed on a NanoDock that can provide the physical interface to the PC-104 subsystem stack. In the picture below a NanoMind A3200 and a NanoCom AX100 is mounted next to each other on top a NanoDock DMC-3.



The AX100 comes with a black-anodized aluminum shield that serves both as an EMI shield and a heat sink. The shield is mounted flush to the PCB ground plane on the upper side and is fixed with 12 hex screws.

## 13 Disclaimer

The information in this document is subject to change without notice and should not be construed as a commitment by GomSpace. GomSpace assumes no responsibility for any errors that may appear in this document.

In no event shall GomSpace be liable for incidental or consequential damages arising from use of this document or the software and hardware described in this document.

# 14 Mechanical Drawing

All dimensions in mm.

