

gomspace.com

NanoSense M315

Datasheet

Compact low noise magnetometer for high performance attitude determination systems

Product name: NanoSense M315

Document No.: 1018558

Revision: 1.2

Author: MABO

Approved by: MB

Approval date: 2019

Confidentiality Notice

This document is submitted for a specific purpose as agreed in writing and contains information, which is confidential and proprietary. The recipient agrees by accepting this document, that this material will not be used, transferred, reproduced, modified, copied or disclosed in whole or in part, in any manner or to any third party, except own staff to meet the purpose for which it was submitted without prior written consent.

GomSpace © 2019

1 Table of Contents

2	OVERVIEW	4
2.1	Highlighted Features.....	4
2.2	Usage.....	4
2.3	3-Axis Magnetometer.....	4
2.4	Block Diagram	5
3	HARDWARE LAYOUT	5
3.1	Connector Location.....	5
3.2	P1 - I ² C	5
4	ABSOLUTE MAXIMUM RATINGS	6
5	ELECTRICAL CHARACTERISTICS	6
6	PHYSICAL CHARACTERISTICS	6
7	PRODUCT CHARACTERISTICS	6
8	MECHANICAL DRAWING.....	7
9	DISCLAIMER	7
10	NANONSENSE M315 WITH OTHER GOMSPACE PRODUCTS	8

2 Overview

The NanoSense M315 (M315) is a flight proven compact and low noise magnetometer with an I²C interface designed especially for nano-satellites with high ADCS requirements. The compact design allows flexible mounting which in turns allows the magnetometer to be placed far away from magnetic disturbance sources.

2.1 Highlighted Features

- 3-axis magnetometer with a range of up to $\pm 800 \mu\text{T}$
- Small, reliable, light
- Low power
- Digital interface (I²C slave)
- Very low noise
- Integrated temperature sensor
- Mass: 8 g
- Size 23 x 20 x 8 mm
- Flight proven

2.2 Usage

A magnetometer is a crucial part of a satellite attitude determination and control system, both for detumbling and attitude determination. The reliability and fast sample time makes the M315 perfectly suited for detumbling applications and its very low noise makes it equally suited for high performance attitude determination.

The M315 is a highly accurate and low noise sensor with a very low temperature dependency. However, it is important to note that it can be difficult to achieve the lowest noise due to magnetic noise in near field environment. It is important to place the sensor as far as possible from current consuming devices as possible. It is also advised to place the sensor as far as possible away from hard and soft iron sources.

Due to its small size, the M315 can be fitted into many locations on a nano-satellite including on a deployable boom for lower magnetic disturbances.

2.3 3-Axis Magnetometer

The directions of the 3-axis are shown in the drawing below.

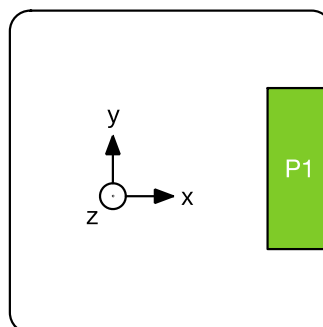

2.4 Block Diagram

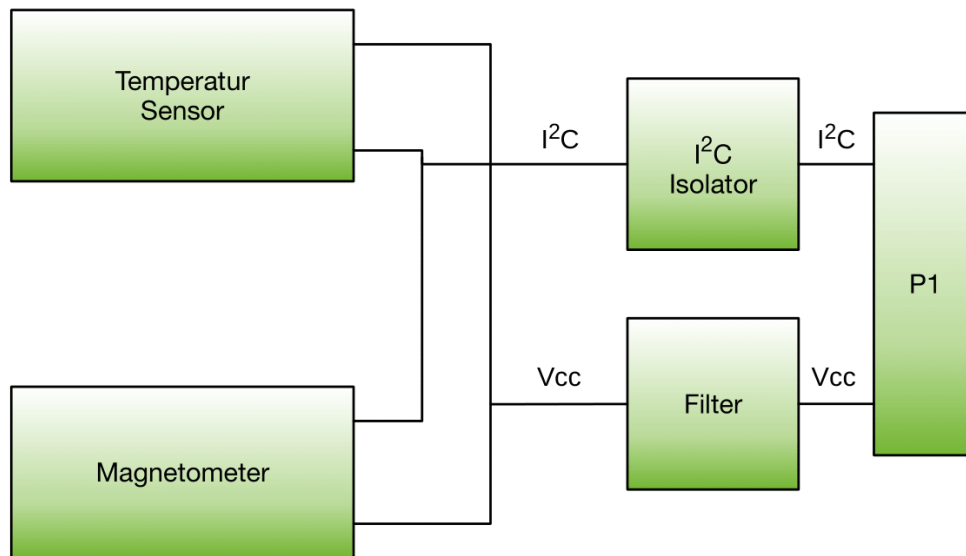

3 Hardware Layout

3.1 Connector Location

Drawing below is seen from the front.

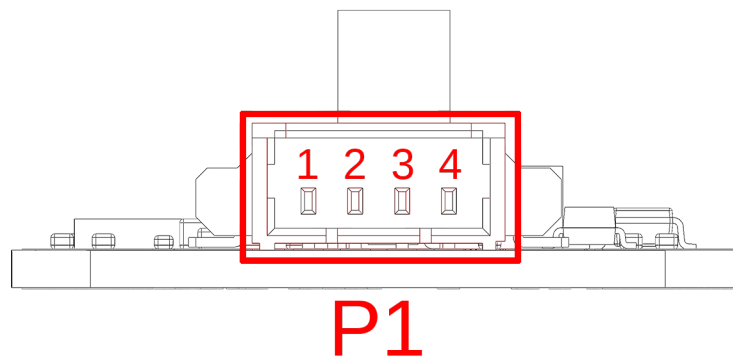

3.2 P1 - I²C

Pico-blade 1.25 mm Pitch. Molex 53261-0471.

Pin	Description
1	Vcc
2	GND
3	SDA
4	SCL

4 Absolute Maximum Ratings

Stresses above those listed under Absolute Maximum Rating may cause permanent damage to the device. Exposure to absolute maximum rating conditions for extended periods may effect the reliability.

Parameter	Description	Min	Typ.	Max	Unit
Vcc	Maximum supply range	-0.3		6.0	V
Vio	Voltage on SDA and SCL	-0.3		5.0	V
T _{op}	Operational temperature range	-40		85	°C
T _{st}	Storage temperature range	-40		85	°C

5 Electrical Characteristics

Parameter	Description	Min	Typ.	Max	Unit
Vcc	Supply voltage	3.2	3.3	5.0	V
Icc	Supply current (Not sampling)		100		µA
Icc	Supply current (Sampling)		2.5		mA
F _{izc}	I ² C frequency		100	400	kHz
I ² C add	Magnetometer		0x20 ¹		hex
I ² C add	Temperature sensor		0x48 ¹		hex

¹ I²C addresses can be switched to an alternative address upon request when ordering

6 Physical Characteristics

Description	Value	Unit
Mass	8	g
Size	23 x 20 x 8	mm

7 Product Characteristics

Parameter	Condition	Value
Noise (1-sigma)	No external magnetic disturbances	15 nT
Sample frequency	Max	140 Hz
Range		± 800 µT
Linearity	At +/- 200 uT	0.5 %
Temperature dependency		<0.1 nT/°C
Temperature measurement accuracy	Typical	+/- 1 °C

8 Mechanical Drawing

All dimension in mm.

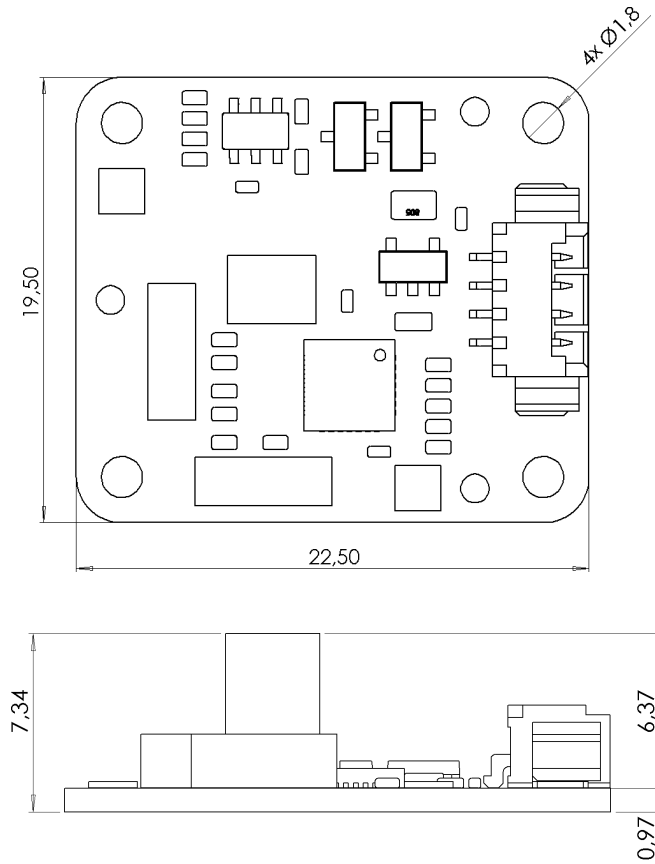

9 Disclaimer

The information in this document is subject to change without notice and should not be construed as a commitment by GomSpace. GomSpace assumes no responsibility for any errors that may appear in this document.

In no event shall GomSpace be liable for incidental or consequential damages arising from use of this document or the software and hardware described in this document.

10 NanoSense M315 with other GomSpace Products

The list below are GomSpace products that can interface directly with the M315.

The **NanoMind A3200** has a connector that the M315 can be plugged into directly, but usually both the A3200 and the M315 is connected to a **NanoUtil Interstage GSSB**.



Figure 1 NanoMind A3200

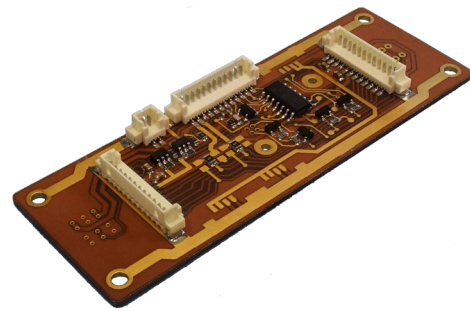

Figure 2 NanoUtil GSSB Type A

Both the **NanoDock ADCS-3** and **NanoDock ADCS-6** can be connected directly. Both units are designed to be the central part of a ADCS system. Options to mount a dedicated A3200, a GPS and either reactions wheels or reaction wheel control electronics. Both docks also contain a number of connectors to peripheral units.

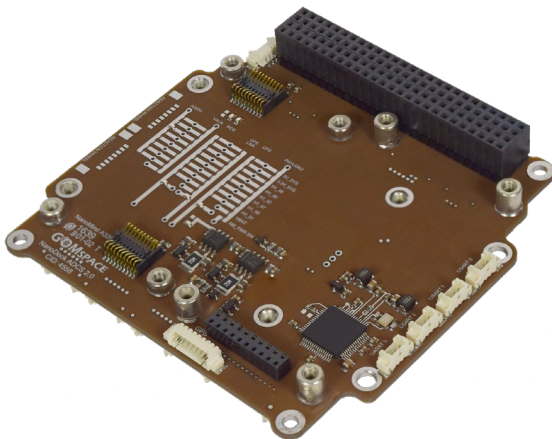

Figure 3 NanoDock ADCS-3

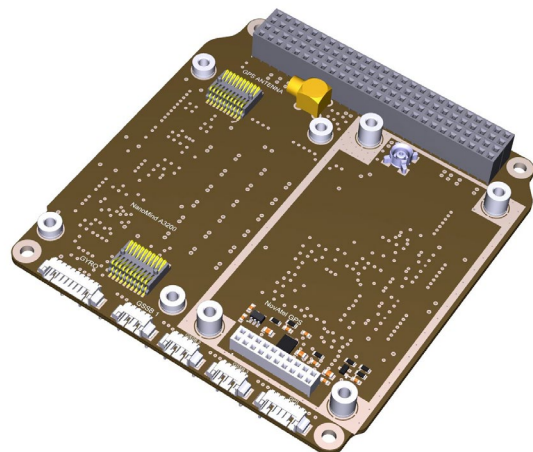

Figure 4 CAD of NanoDock ADCS-6